

**KLT-T5K-OV7675 V1.0 NIR****0.3MP OmniVision OV7675 DVP Parallel Interface No IR Filter
Fixed Focus Camera Module**

Front View



Back View

Specifications

Camera Module No.	KLT-T5K-OV7675 V1.0 NIR
Resolution	0.3MP
Image Sensor	OV7675
Sensor Type	1/9"
Pixel Size	2.5 um x 2.5 um
EFL	1.90 mm
F.NO	2.80
Pixel	640 x 480
View Angle	57.0°(DFOV)
Lens Dimensions	5.00 x 5.00 x 2.85 mm
Module Size	19.50 x 12.50 mm
Module Type	Fixed Focus
Interface	DVP Parallel
Auto Focus VCM Driver IC	None
Lens Model	KLT-LENS-TR01A-H550A
Lens Type	No IR Filter Lens
Operating Temperature	-30°C to +70°C
Mating Connector	FH12-24S-0.5SH



KLT-T5K-OV7675 V1.0 NIR
0.3MP OmniVision OV7675 DVP Parallel Interface No IR Filter
Fixed Focus Camera Module

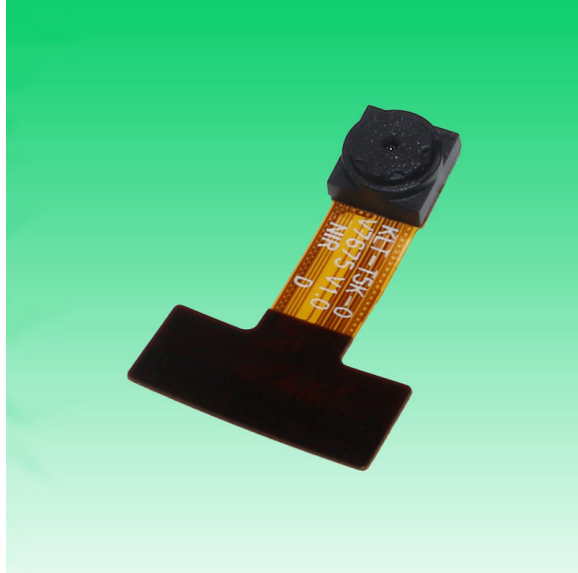

Top View



Side View



Bottom View

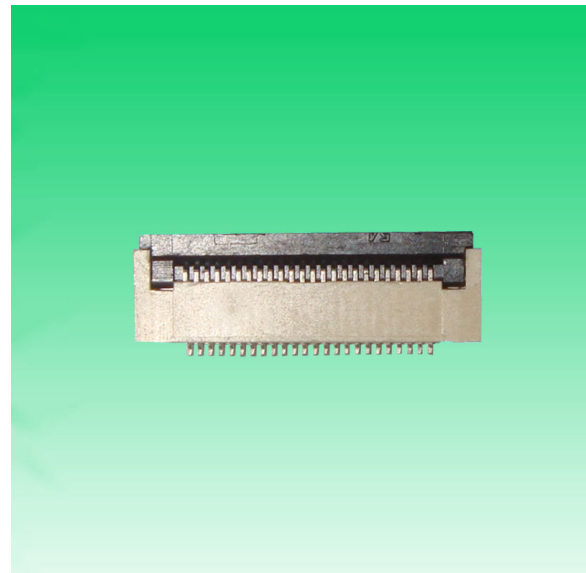

Mating Connector

CONNECTOR
24PIN DESCRIPTION

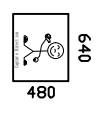

ROHS

PIN	SIGNAL
1	NC
2	AGND
3	SID_D
4	AVDD 2.8V
5	SID_C
6	NC
7	VSYNC
8	PWIND
9	HREF
10	NC
11	DDVDD
12	D7
13	XCLK
14	D6
15	DGND
16	D5
17	PCLK
18	D4
19	D0
20	D3
21	D1
22	D2
23	DGND
24	DGND

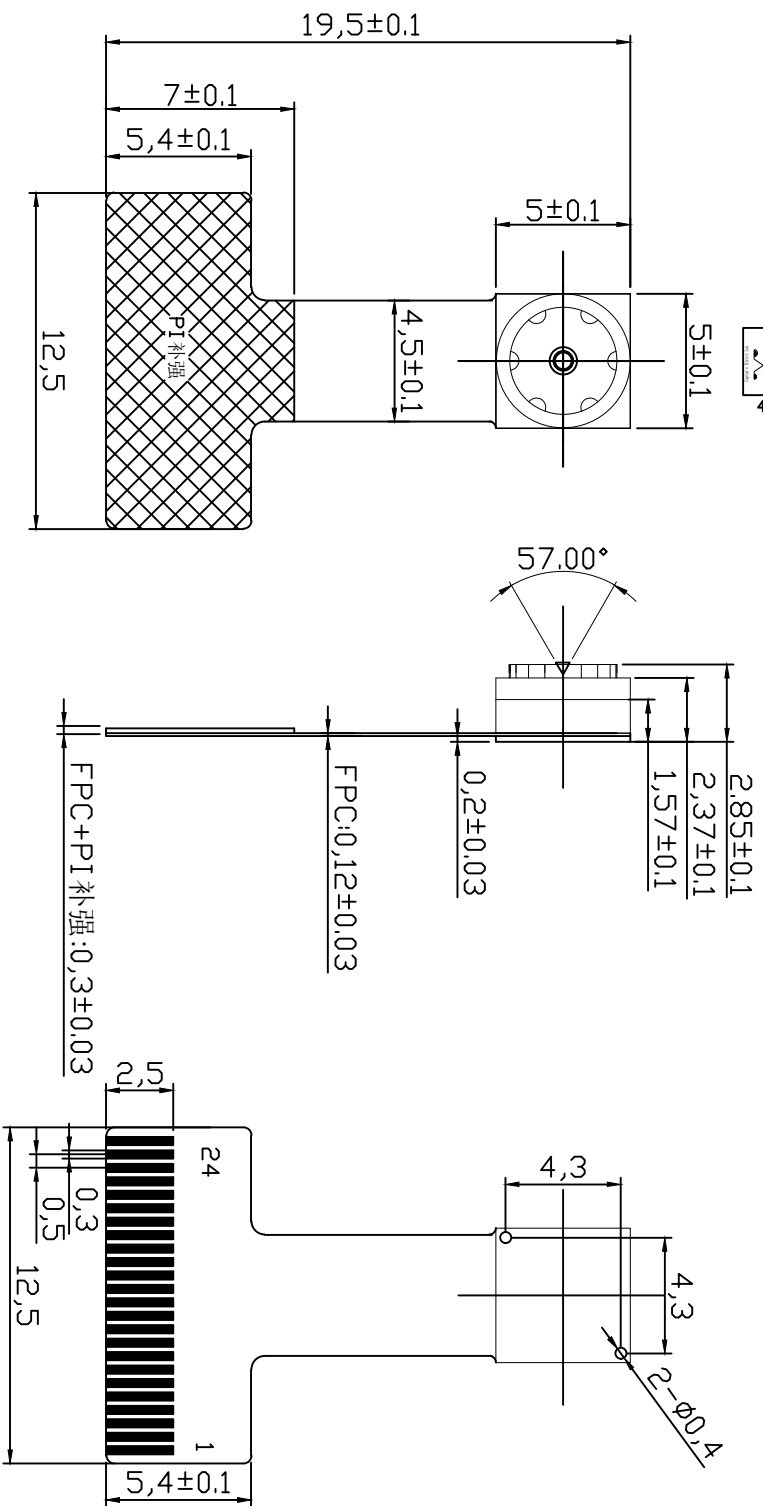

SELECT	level	A	B	C	D
~ 5	dim	±0.03	±0.05	±0.08	±0.10
5~10		±0.05	±0.08	±0.10	±0.15
10~50		±0.08	±0.10	±0.15	±0.20
50~100		±0.10	±0.15	±0.20	±0.25
100~		±0.10%	±0.15%	±0.20%	±0.30%

Parameter	Value
EFL	1.9mm
F/NO	2.8
View Angle	57°
Distortion	<1.0%
Depth Of Field	pixel
Lens T type	1/9inch
Image Sensor	DV7675

1/0	All	First Release	Kevin	7/5/2019
REV.	Zone	Description	Approved	Date
Kai Lap Technologies Group Ltd				
Designed By: Kevin		Client Name: 7675		
Checked By: Feng Liu		Model Name: KLT-TSK-DV7675 V1.0 NIR		
Approved By: Aouly_Yan		Projection Type: Third Angle		
		Unit: mm		
		Material: -----		
		Scale: 1:1		
		Sheet: 1 of 1		
		Version: 1/0		



Lens Model: KLT-LENS-TR01A-H550A

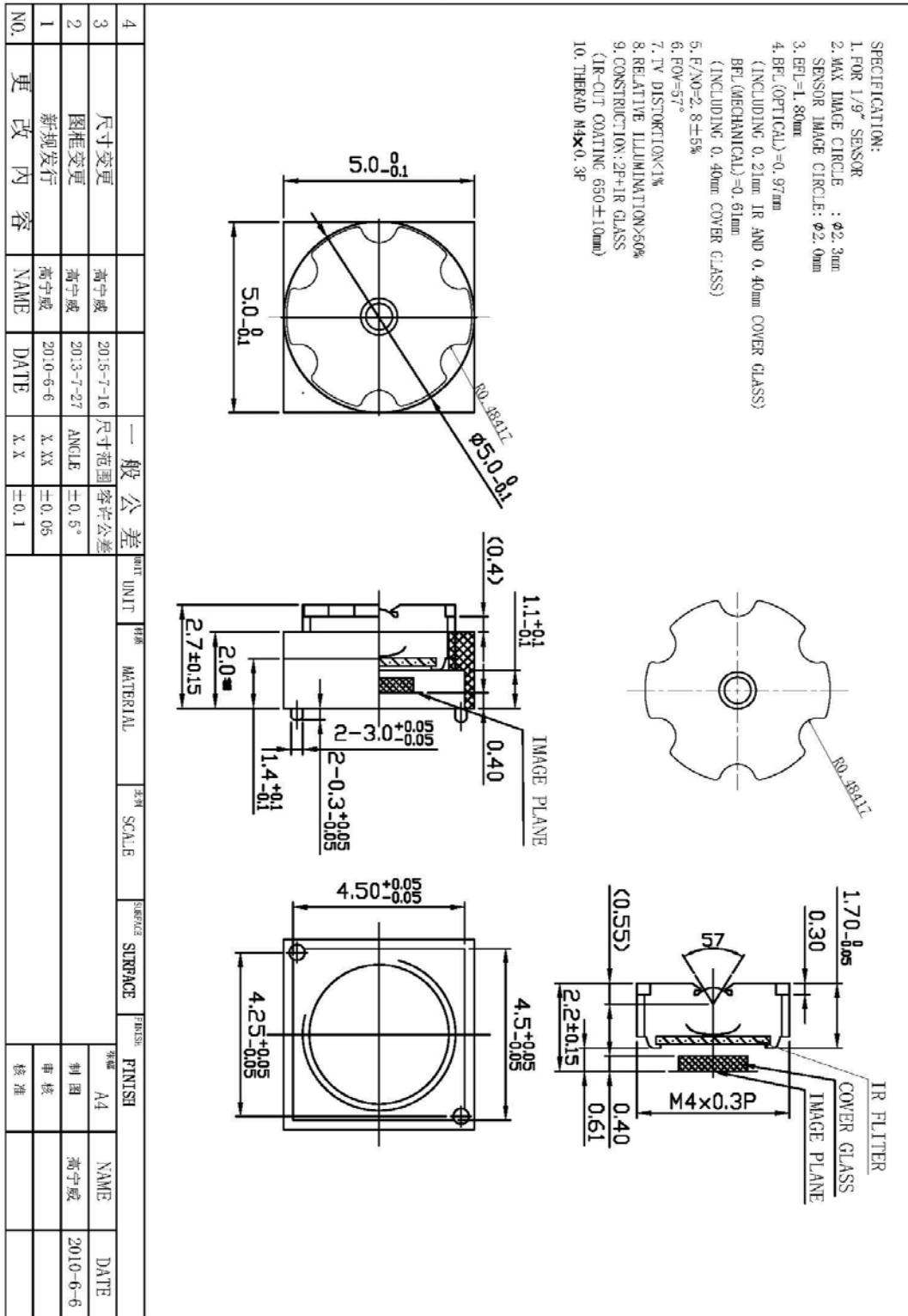

0.5mm and 1mm Pitch Connectors For FPC/FFC

FH12 Series

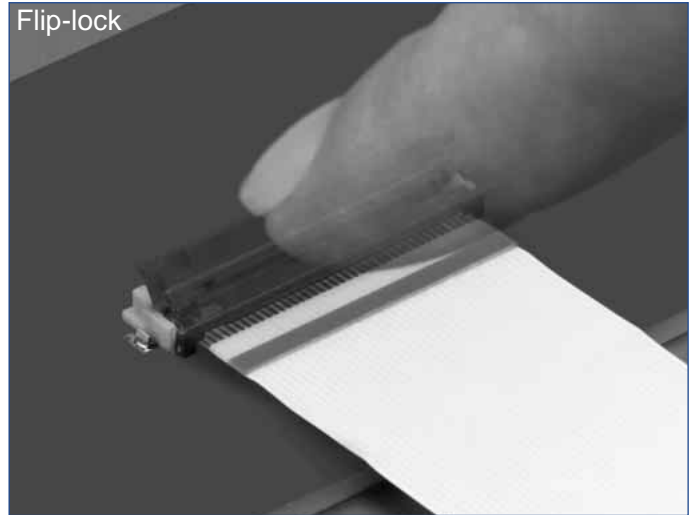
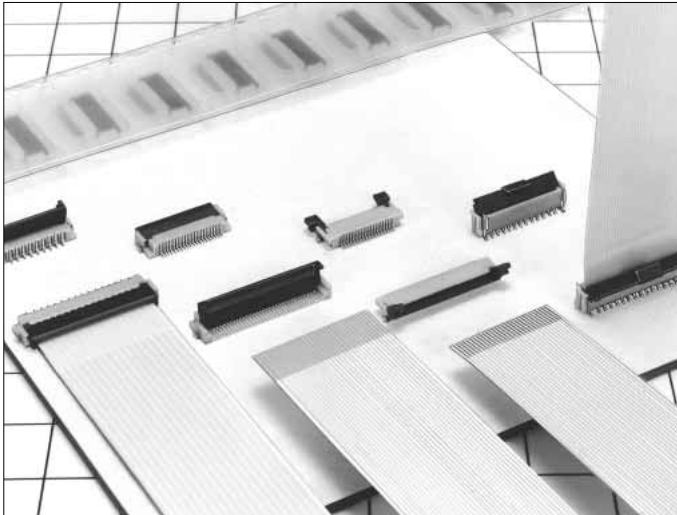

■ Features

1. Ease of Use and Space Savings

Only one finger or 6.9N (Newtons) of force is required to lock Hirose's rotational actuator (flip-lock) as compared to using 2 fingers and 39.2N to close a FFC/FPC connector from our competition.

The Flip-Lock design also allows customers to place 2 or more connectors side by side as there is no need to waste additional board space for a side latch.

2. Strengthened Flip-lock Actuator

The standard Flip-Lock requires only 2.0mm height above the board. A strengthened lock lever is available which only requires an additional 0.4mm.

3. Supports Thin FPC (0.18mm)

Hirose does not require double-sided FPC to have any additional strengthening plate or stiffener and can therefore support a thickness of as little as 0.18mm +/- 0.05.

4. Hirose Ensures Reliability

Hirose's patented half tuning fork contacts maintain the required normal force without relying on the connector housing. With our competitor's conventional products the housing walls support the contact force, which does not provide for long-term reliability.

5. Prevention of Solder Bridge

Excess solder cavity absorbs excessive solder and avoids solder bridging.

6. Three different assembly types

FH12 is offered in Top & Bottom Contact and Vertical Mount and offered in both a 0.5mm contact pitch as well as a 1.0mm contact pitch (bottom contact only).

■ Applications

Notebook computers, printers, PDAs, digital cameras and other compact devices for interconnecting the main circuit board with the LCD, HDD or other device.

Rotating One-touch Mechanism

①

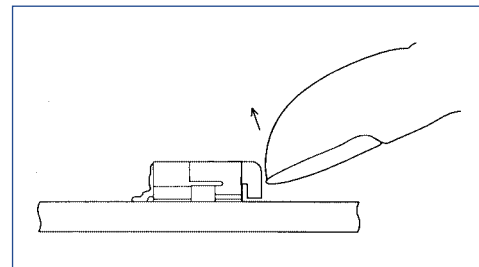

②

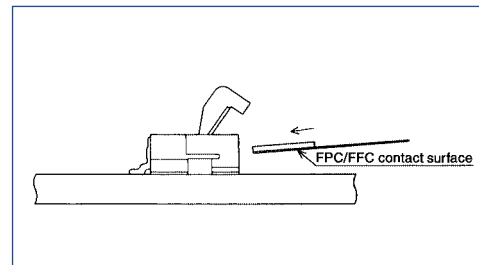

③



Product Specifications

Rating	Current rating: 0.5A DC(Note 1)	Operating Temperature Range: -40 to +70°C (Note 2)	Storage Temperature Range: -10 to +50°C (Note 3)
	Voltage rating: 50V AC	Operating Humidity Range: Relative humidity, 90% max. (Not dewed)	Storage Humidity Range: Relative humidity, 90% max. (Not dewed)

Applicable FPC	t=0.3±0.05 Gold plated	t=0.18 ± 0.05 for FH12F-*S-0.5SH
----------------	------------------------	----------------------------------

Item	Specification	Conditions
1. Insulation resistance	500M ohms minimum	100V DC
2. Withstanding voltage	No flashover or insulation breakdown.	150V AC/1 minute
3. Contact resistance	50m ohms maximum	1mA
4. Durability (Insertion/withdrawal)	Contact resistance: 50m ohms maximum No damage, cracks, or parts dislocation.	20 cycles
5. Vibration	No electrical discontinuity of 1μs or more Contact resistance: 50m ohms maximum. No damage, cracks, or parts dislocation.	Frequency: 10 to 55 Hz, single amplitude of 0.75 mm, 2 hours in each of the 3 directions.
6. Shock	No electrical discontinuity of 1μs or more Contact resistance: 50m ohms maximum. No damage, cracks, or parts dislocation.	Acceleration of 490 m/s ² , 11 ms duration, sine half-wave waveform, 3 cycles in each of the 3 axis.
7. Humidity(Steady state)	Contact resistance: 50m ohms maximum. Insulation resistance: 50M ohms minimum. No damage, cracks, or parts dislocation.	96 hours at 40°C and humidity of 90% to 95%
8. Temperature Cycle	Contact resistance: 50m ohms maximum. Insulation resistance: 50M ohms minimum. No damage, cracks, or parts dislocation.	Temperature: -40°C → 15 to 35°C → 85°C → 15 to 35°C, Time: 30 → 5 max. → 30 → 5 max.(minutes) 5 cycles
9. Resistance to Soldering heat	No deformation of components affecting performance.	Reflow: At the recommended temperature profile Manual soldering: 350±5°C for 3 seconds

Note 1: When passing the current through all of the contacts, use 70% of the current rating.

Note 2: Includes temperature rise caused by current flow.

Note 3: The term "storage" refers to products stored for long period of time prior to mounting and use. Operating Temperature Range and Humidity range covers nonconducting condition of installed connectors in storage, shipment or during transportation.

Material

Part	Material	Finish	Remarks
Insulator	Polyamide, LCP(60 pos.)	Color : Beige	UL94V-0
Actuator	PPS	Color : Dark brown	
Contact	Phosphor bronze	Gold plated	
Metal Fittings	Brass	Tin plated	

Ordering Information

FH12 **A** - **10** (**4**) - **S** **A** - **0.5** **SH** (**55**)
 ① ② ③ ④ ⑤ ⑥ ⑦ ⑧ ⑨

① Series Name : FH12	⑤ Contact alignment: Single
② Blank : standard type A : Top contact type S : Type with strengthened flip-lock actuator F : Type with 0.18mm FPC End Thickness	⑥ Eccentric direction: Blank : standard type A : Eccentric type
③ Standard type : Number of contacts Eccentric type : Number of contacts in 0.5mm housing	⑦ Contacts Pitch : 0.5mm, 1mm
④ Standard type : Blank Eccentric type : Number of contacts	⑧ Contact type SH : SMT horizontal mounting type SV : SMT vertical mounting type
	⑨ Plating specification (55) : Gold plated

FH12 Series 0.5mm and 1mm Pitch Connectors For FPC/FPC

Series Configuration

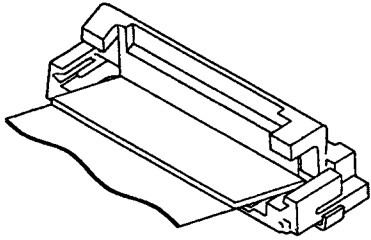
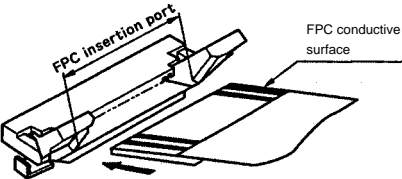
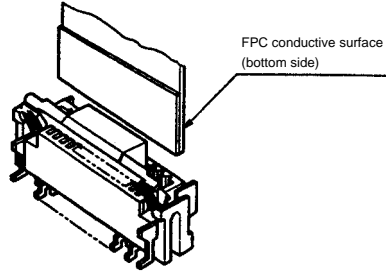
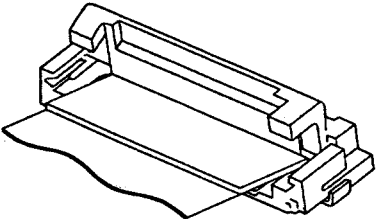
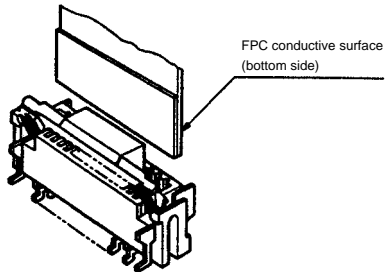
Pitch	Bottom Contact Type	Top Contact Type	Vertical mounting Type
0.5mm	 <p>FH12- ** S-0.5SH P.12 Number of contacts 6, 8, 10, 11, 12, 13, 14, 15, 16, 17, 18, 19, 20, 22, 24, 25, 26, 28, 30, 32, 33, 34, 35, 36, 40, 45, 50, 53</p>		
	Type with Strengthened Lock Lever		
	<p>FH12S- ** S-0.5SH P.13 Number of contacts 30, 40, 45, 50, 53</p>		
	Type with 0.18mm FPC End Thickness		
	<p>FH12F- ** S-0.5SH P.14 Number of contacts 6, 8, 10, 12, 13, 14, 15, 16, 18, 20, 22, 24, 25, 26, 28, 30, 32, 34, 36, 40</p>		
1mm	 <p>Standard FH12- ** S-1SH P.18 Eccentric FH12- ** (***) SA-1SH Standard Number of contacts 5, 6, 7, 8, 9, 11, 12, 16, 17, 22, 26 Eccentric Number of contacts 4, 6, 8, 10, 11, 14, 19, 24</p>		 <p>FH12- ** S-1SV P.19 Number of contacts 6, 7, 8, 16, 20, 22, 24</p>

0.5mm Pitch Bottom Contact Type

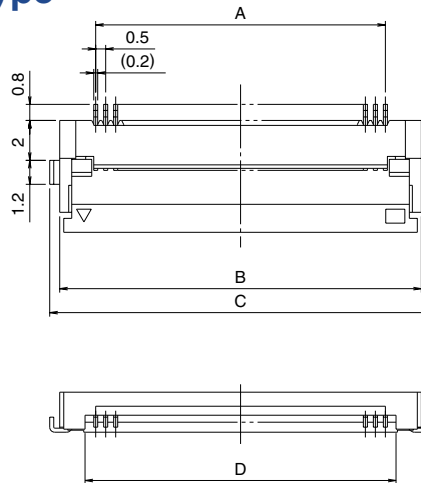

Mated Cross-sectional Diagram

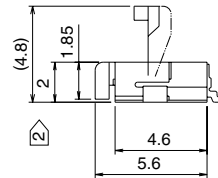
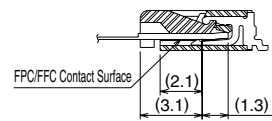

Unit:mm

Part Number	CL No.	Number of Contacts	A	B	C	D	RoHS
FH12- 6S-0.5SH(55)	586-0582-5-55	6	2.5	6.1	7.1	3.57	YES
FH12- 8S-0.5SH(55)	586-0744-5-55	8	3.5	7.1	8.1	4.57	
FH12-10S-0.5SH(55)	586-0522-3-55	10	4.5	8.1	9.1	5.57	
FH12-11S-0.5SH(55)	586-0600-5-55	11	5	8.6	9.6	6.07	
FH12-12S-0.5SH(55)	586-0704-0-55	12	5.5	9.1	10.1	6.57	
FH12-13S-0.5SH(55)	586-0549-0-55	13	6	9.6	10.6	7.07	
FH12-14S-0.5SH(55)	586-0533-0-55	14	6.5	10.1	11.1	7.57	
FH12-15S-0.5SH(55)	586-0523-6-55	15	7	10.6	11.6	8.07	
FH12-16S-0.5SH(55)	586-0531-4-55	16	7.5	11.1	12.1	8.57	
FH12-17S-0.5SH(55)	586-0606-1-55	17	8	11.6	12.6	9.07	
FH12-18S-0.5SH(55)	586-0530-1-55	18	8.5	12.1	13.1	9.57	
FH12-19S-0.5SH(55)	586-0534-2-55	19	9	12.6	13.6	10.07	
FH12-20S-0.5SH(55)	586-0524-9-55	20	9.5	13.1	14.1	10.57	
FH12-22S-0.5SH(55)	586-0532-7-55	22	10.5	14.1	15.1	11.57	
FH12-24S-0.5SH(55)	586-0521-0-55	24	11.5	15.1	16.1	12.57	
FH12-25S-0.5SH(55)	586-0692-3-55	25	12	15.6	16.6	13.07	
FH12-26S-0.5SH(55)	586-0576-2-55	26	12.5	16.1	17.1	13.57	
FH12-28S-0.5SH(55)	586-0612-4-55	28	13.5	17.1	18.1	14.57	
Note ② FH12-30S-0.5SH(55)	586-0525-1-55	30	14.5	18.1	19.1	15.57	
FH12-32S-0.5SH(55)	586-0681-7-55	32	15.5	19.1	20.1	16.57	
FH12-33S-0.5SH(55)	586-0520-8-55	33	16	19.6	20.6	17.07	
FH12-34S-0.5SH(55)	586-0617-8-55	34	16.5	20.1	21.1	17.57	
FH12-35S-0.5SH(55)	586-0740-4-55	35	17.0	20.6	21.6	18.07	
FH12-36S-0.5SH(55)	586-0526-4-55	36	17.5	21.1	22.1	18.57	
Note ② FH12-40S-0.5SH(55)	586-0527-7-55	40	19.5	23.1	24.1	20.57	
Note ② FH12-45S-0.5SH(55)	586-0528-0-55	45	22	25.6	26.6	23.07	
Note ② FH12-50S-0.5SH(55)	586-0529-2-55	50	24.5	28.1	29.1	25.57	
Note ② FH12-53S-0.5SH(55)	586-0595-7-55	53	26	29.6	30.6	27.07	

Note 1 : Embossed tape reel packaging (2,000 pieces/reel).
 Order by number of reels.

Note ② : If there is no problem with the connector height, we recommend the type with the strengthened Flip-lock actuator (FH12S-*S-0.5SH).
 Standard type connector height: 2 mm
 Connector height of type with strengthened Flip-lock actuator: 2.4 mm

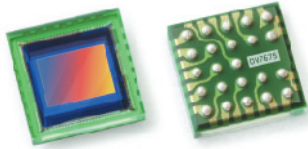

OV7675 VGA product brief



Higher Performance, Feature Rich VGA Sensor to Support Fast Growing Emerging Markets



available in
a lead-free
package

The OV7675 is a high performance VGA sensor designed specifically to address growing demand for consumer electronics from emerging markets. Its small optical format enables ultra-thin camera modules, which, combined with its excellent low-light performance, make it a very attractive solution for entry-level and mainstream mobile phones, notebooks, netbooks and webcams.

The OV7675 is a low-voltage color CMOS image sensor that supports the full functionality of a single chip VGA (640 x 480) camera in a small footprint package. The 1/9-inch OV7675 uses a unique 2.5-micron OmniPixel3-HS™ pixel design, which allows it to offer best-in-class low-light sensitivity (1800 mV/lux-sec), significantly reduced noise and outstanding color reproduction.

The OV7675 provides full-frame, sub-sampled, windowed images in VGA, QVGA and QQVGA formats via the control of the serial camera control bus (SCCB) interface. Its image array is capable of operating at up to 30 frames per second (fps) in full VGA resolution with complete user control over image quality, formatting and output data transfer.

All required image processing functions, including exposure control, gamma, white balance, color saturation, hue control, defective pixel canceling, noise canceling are programmable through the SCCB interface. In addition, OmniVision image sensors use proprietary sensor technology to improve image quality by reducing or eliminating common lighting/electrical sources of image contamination, such as fixed pattern noise and smearing to produce a clean, fully stable color image.

Find out more at www.ovt.com.

Applications

- Mobile Phones
- Notebooks/Netbooks and Webcams

Product Features

- support for image sizes: VGA (640 x 480), QVGA (320 x 240) and QQVGA (160 x 120)
- support for output formats: YUV4:2:2, RAW RGB, ITU656, RGB565
- digital video port (DVP) parallel output interface
- on-chip phase lock loop (PLL)
- built-in 1.5V regulator for core
- capable of maintaining register values at power down
- programmable controls for frame rate, mirror and flip, AEC/AGC, and windowing
- support for horizontal and vertical sub-sampling
- automatic image control functions:
 - automatic exposure control (AEC)
 - automatic white balance (AWB)
 - automatic black level calibration (ABLC)
- image quality controls: defect pixel correction and lens shading correction
- support for black sun cancellation
- standard serial SCCB interface
- parallel I/O tri-state configurability and programmable polarity
- module size: 6 mm x 6 mm

OV7675

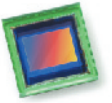

Ordering Information

- **OV07675-A23A**
(color, lead-free, 23-pin CSP3)
- **OV07675-G04A**
(color, chip probing, 200 μ m backgrounding, reconstructed wafer)
- **OV07175-A23A**
(B&W, lead-free, 23-pin CSP3)

Product Specifications

- **active array size:** 640 x 480
- **power supply:**
 - analog: 2.6 - 3.0 V
 - core: 1.5 V \pm 5% (internal regulator)
 - I/O: 1.71 - 3.0 V
- **power requirements:**
 - active: 98 mW
 - standby: 60 μ W
- **temperature range:**
 - operating: -30°C to 70°C junction temperature
 - stable image: 0°C to 50°C junction temperature
- **output formats:** YUV422, RAW RGB, ITU656, RGB565
- **lens size:** 1/9"
- **lens chief ray angle:** 21°
- **input clock frequency:** 1.5 - 27 MHz
- **scan mode:** progressive
- **maximum image transfer rate:**
 - VGA: 30 fps
 - QVGA: 60 fps
 - QQVGA: 240 fps
- **sensitivity:** 1800 mV/lux-sec
- **shutter:** rolling shutter
- **max S/N ratio:** 38 dB
- **dynamic range:** 71 dB @ 8x gain
- **maximum exposure interval:** 510 x t_{row}
- **pixel size:** 2.5 μ m x 2.5 μ m
- **dark current:** 10 mV/s @ 60°C junction temperature
- **image area:** 1640 μ m x 1220 μ m
- **package dimensions:**
 - CSP3: 2815 μ m x 2825 μ m
 - COB: 2830 μ m x 2840 μ m

Functional Block Diagram

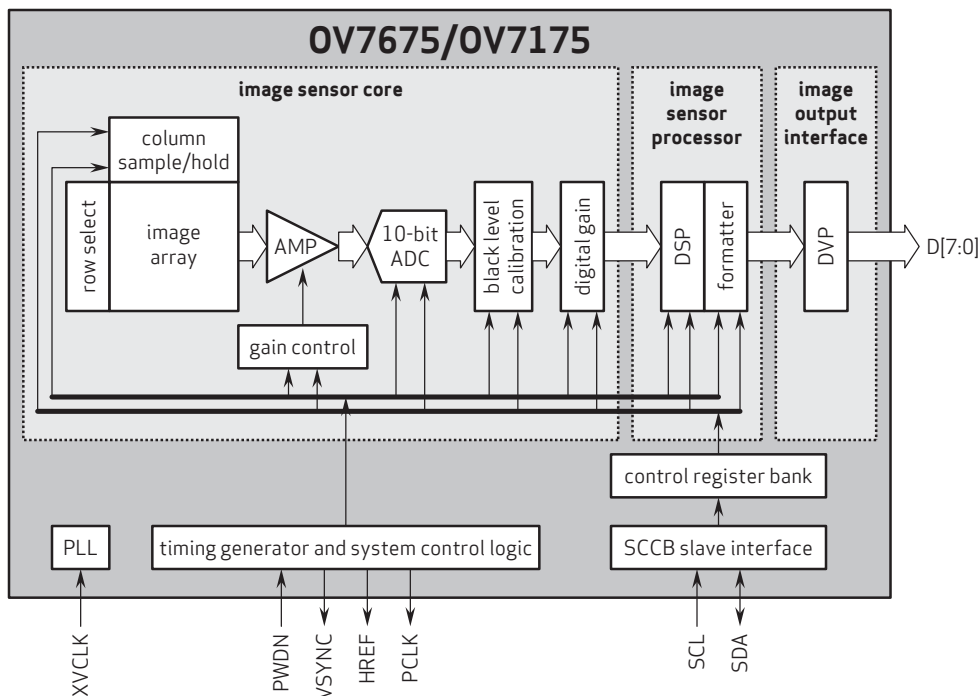

4275 Burton Drive
Santa Clara, CA 95054
USA

Tel: + 1 408 567 3000
Fax: + 1 408 567 3001
www.ovt.com

OmniVision reserves the right to make changes to their products or to discontinue any product or service without further notice. OmniVision, the OmniVision logo and OmniPixel are registered trademarks of OmniVision Technologies, Inc. OmniPixel3-H5 is a trademark of OmniVision Technologies, Inc. All other trademarks are the property of their respective owners.



Camera Module Pinout Definition Reference Chart

OmniVision	Sony	Samsung	On-Semi	Aptina	Himax	GalaxyCore	PixArt	SmartSens	Sensors
Pin Signal									
Description									
DGND	GND								
AGND									
PCLK	DCK								
XCLR	PWDN	XSHUTDOWN	STANDBY						
MCLK	XVCLK	XCLK	INCK						
RESET	RST								
NC	NULL								
SDA	SIO_D	SIOD							
SCL	SIO_C	SIOC							
VSYNC	XVS	FSYNC							
HREF	XHS								
DOVDD									
AFVDD									
AVDD									
DVDD									
STROBE	FSTROBE								
FSIN									
SID									
ILPWM									
FREX									
GPIO									
SLASEL									
AFEN									
MIPI Interface									
MDN0	DN0	MD0N	DATA_N	DMO1N					
MDP0	DP0	MD0P	DATA_P	DMO1P					
MDN1	DN1	MD1N	DATA2_N	DMO2N					
MDP1	DP1	MD1P	DATA2_P	DMO2P					
MDN2	DN2	MD2N	DATA3_N	DMO3N					
MDP2	DP2	MD2P	DATA3_P	DMO3P					
MDN3	DN3	MD3N	DATA4_N	DMO4N					
MDP3	DP3	MD3P	DATA4_P	DMO4P					
MCN	CLKN	CLK_N	DCKN						
MCP	CLKP	MCP	CLK_P	DCKN					
DVP Parallel Interface									
D0	DO0	Y0							
D1	DO1	Y1							
D2	DO2	Y2							
D3	DO3	Y3							
D4	DO4	Y4							
D5	DO5	Y5							
D6	DO6	Y6							
D7	DO7	Y7							
D8	DO8	Y8							
D9	DO9	Y9							
D10	DO10	Y10							
D11	DO11	Y11							



your **BEST** camera module partner

Cameras Applications

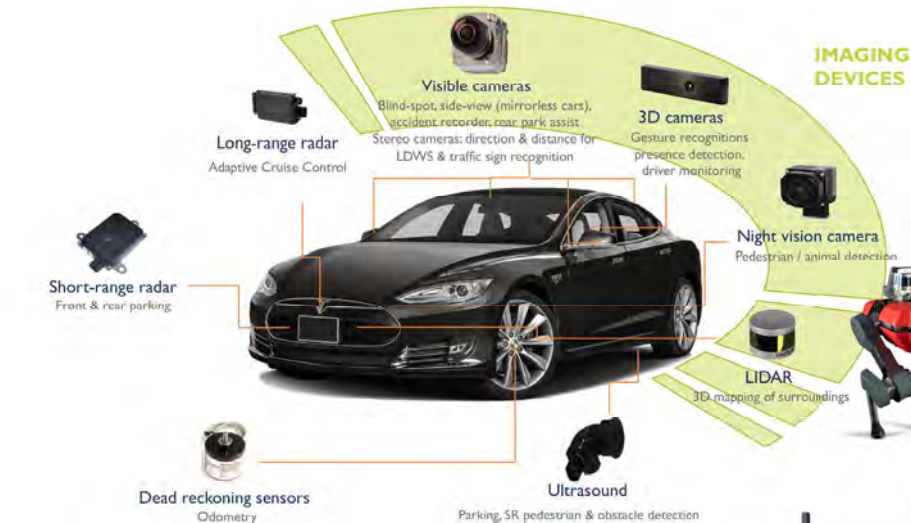



Camera Reliability Test

Reliability Inspection Item		Testing Method	Acceptance Criteria	
Category	Item			
Environmental	Storage Temperature	High 60°C 96 Hours	Temperature Chamber	No Abnormal Situation
		Low -20°C 96 Hours	Temperature Chamber	No Abnormal Situation
	Operation Temperature	High 60°C 24 Hours	Temperature Chamber	No Abnormal Situation
		Low -20°C 24 Hours	Temperature Chamber	No Abnormal Situation
	Humidity	60°C 80% 24 Hours	Temperature Chamber	No Abnormal Situation
	Thermal Shock	High 60°C 0.5 Hours Low -20°C 0.5 Hours Cycling in 24 Hours	Temperature Chamber	No Abnormal Situation
Physical	Drop Test (Free Falling)	Without Package 60cm	10 Times on Wood Floor	Electrically Functional
		With Package 60cm	10 Times on Wood Floor	Electrically Functional
	Vibration Test	50Hz X-Axis 2mm 30min	Vibration Table	Electrically Functional
		50Hz Y-Axis 2mm 30min	Vibration Table	Electrically Functional
		50Hz Z-Axis 2mm 30min	Vibration Table	Electrically Functional
	Cable Tensile Strength Test	Loading Weight 4 kg 60 Seconds Cycling in 24 Hours	Tensile Testing Machine	Electrically Functional
Electrical	ESD Test	Contact Discharge 2 KV	ESD Testing Machine	Electrically Functional
		Air Discharge 4 KV	ESD Testing Machine	Electrically Functional
	Aging Test	On/Off 30 Seconds Cycling in 24 Hours	Power Switch	Electrically Functional
	USB Connector	On/Off 250 Times	Plug and Unplug	Electrically Functional





Inspection Item		Inspection Method	Standard of Inspection		
Category	Item				
Appearance	FPC/ PCB	Color	The Naked Eye	Major Difference is Not Allowed.	
		Be Torn/Chopped	The Naked Eye	Copper Crack Exposure is Not Allowed.	
		Marking	The Naked Eye	Clear, Recognizable (Within 30cm Distance)	
	Holder	Scratches	The Naked Eye	The Inside Crack Exposure is Not Allowed	
		Gap	The Naked Eye	Meet the Height Standard	
		Screw	The Naked Eye	Make Sure Screws Are Presented (If Any)	
		Damage	The Naked Eye	The Inside Crack Exposure is Not Allowed	
	Lens	Scratch	The Naked Eye	No Effect On Resolution Standard	
		Contamination	The Naked Eye	No Effect On Resolution Standard	
		Oil Film	The Naked Eye	No Effect On Resolution Standard	
		Cover Tape	The Naked Eye	No Issue On Appearance.	
	Function	Image	No Communication	Test Board	Not Allowed
			Bright Pixel	Black Board	Not Allowed In the Image Center
Dark Pixel			White board	Not Allowed In the Image Center	
Blurry			The Naked Eye	Not Allowed	
No Image			The Naked Eye	Not Allowed	
Vertical Line			The Naked Eye	Not Allowed	
Horizontal Line			The Naked Eye	Not Allowed	
Light Leakage			The Naked Eye	Not Allowed	
Blinking Image			The Naked Eye	Not Allowed	
Bruise			Inspection Jig	Not Allowed	
Resolution			Chart	Follows Outgoing Inspection Chart Standard	
Color			The Naked Eye	No Issue	
Noise			The Naked Eye	Not Allowed	
Corner Dark			The Naked Eye	Less Than 100px By 100px	
Color Resolution			The Naked Eye	No Issue	
Dimension	Height	The Naked Eye	Follows Approval Data Sheet		
	Width	The Naked Eye	Follows Approval Data Sheet		
	Length	The Naked Eye	Follows Approval Data Sheet		
	Overall	The Naked Eye	Follows Approval Data Sheet		



KLT Package Solutions

KLT Camera Module

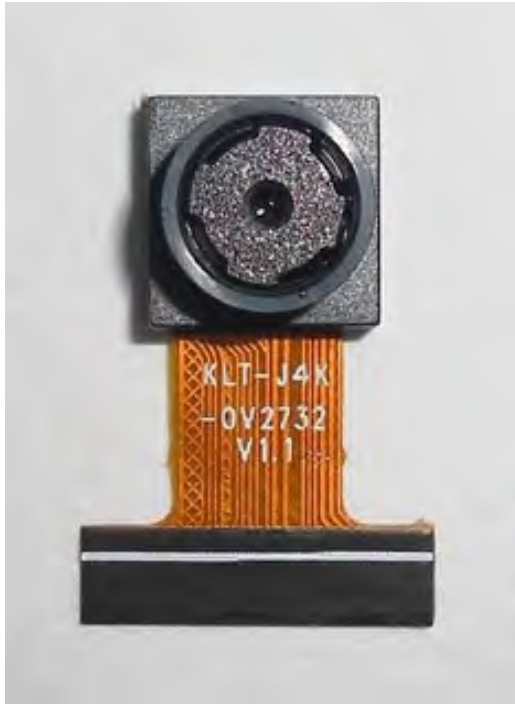

Complete with Lens Protection Film



Tray with Grid and Space



Place Cameras on the Tray

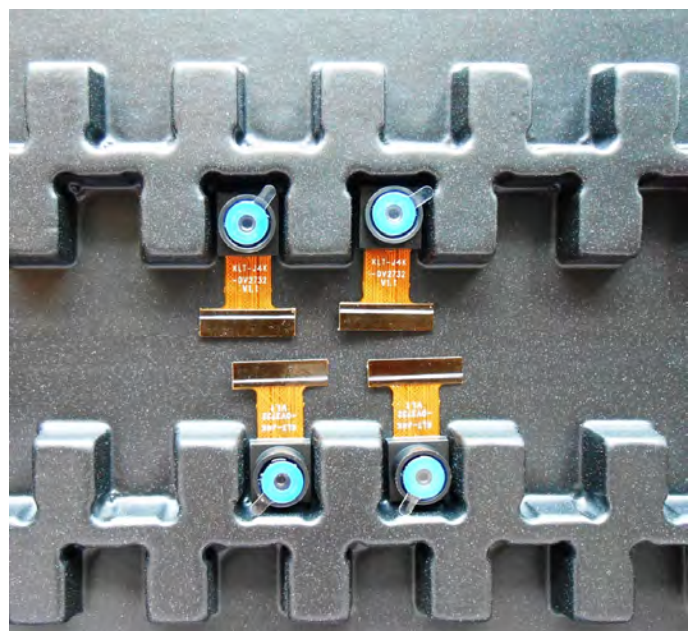

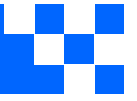

Camera Modules Package Solution

Full Tray of Cameras



Cover Tray with Lid



Put Tray into Anti-Static Bag



Vacuum the Anti-Static Bag

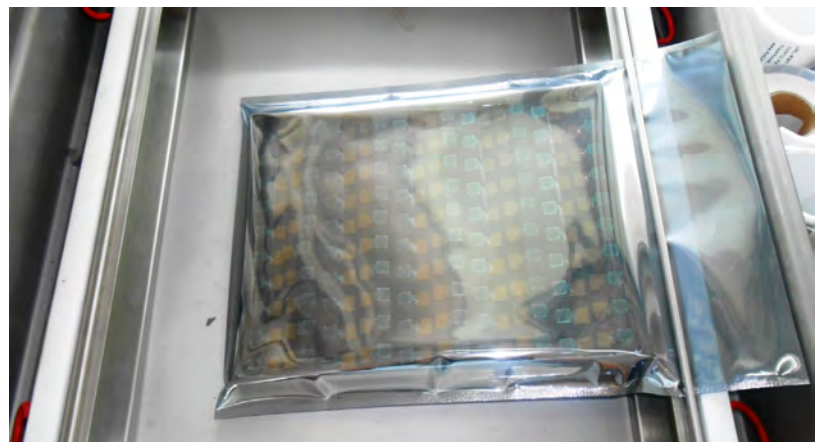



Camera Modules Package Solution

Sealed Vacuum Bag with Labels

1. Model and Description 2. Quantity 3. Shipping Date 4. Caution





Large Order Package Solution

Place Foam Sheets Between Trays



Foam Sheets are Slightly Larger than Trays



Place Foam Sheets and Trays into Box



Foam Sheets are Tightly Fitting Box





Small Order Package Solution

Place Foam Sheets and Trays into Small Box



Foam Sheets are Nicely Fitting the Small Box



Package in Small Box for Shipment



Place Small Boxes into Larger Box





your BEST camera module partner

Carbon Box Package Solution

Seal the Carbon Box

Final Package Labelled Box



Carbon Box Ready for Shipment

1. Delivery Address and Phone No. 2. Box No. and Ship Date 3. Fragile Caution





Sample Order Package Solution

Place Sample into Small Anti-Static Bag



Place Connectors into Small Ant-Static Bag



Sample Labels on the Small Bag

1. Camera Module or Connector Model 2. Shipping Date and Quantity 3. Caution





Connectors Large Order Package Solution

Connectors in a Wheel



Label Connectors in the Wheel



The Wheel is Perfectly Fitting the Box



Connectors Box Ready for Shipment



Company Kai Lap Technologies (KLT)

Kai Lap Technologies Group Limited. (KLT) was established in 2009, a next-generation technology driven manufacturer specialized in research, design, and produce of audio and video products. KLT is occupying 20,000 square feet automated plants with 100 employees of annual throughput 30,000,000 units cameras.

KLT provides OEM, ODM design, contract manufacturing, and builds the camera products. You may provide the requirements to us, even with a hand draft, our sales and engineering work together to meet your needs. We consider ourselves your last-term partner in developing practical and innovative solutions.

Our team covers everything from initial concept development to mass produced product. KLT specializes in customized camera design, raw material, electronic engineering, firmware/software development, product testing, and packing design. Our experienced strategic supply systems offer a robust and dependable manufacturing capacity for orders of various sizes.

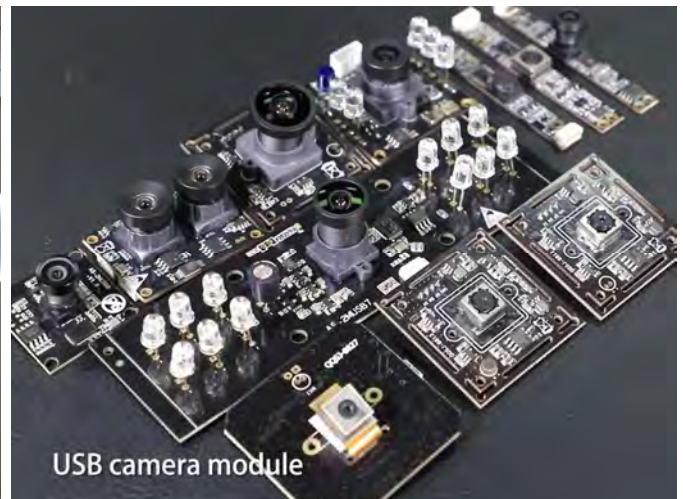

Limited Warranty

KLT provides the following limited warranty if you purchased the Product(s) directly from KLT company or from KLT's website, www.KaiLapTech.com. Product(s) purchased from other sellers or sources are not covered by this Limited Warranty. KLT guarantees that the Product(s) will be free from defects in materials and workmanship under normal use for a period of one (1) year from the date you receive the product ("Warranty Period").

For all Product(s) that contain or develop material defects in materials or workmanship during the Warranty Period, KLT will, at its sole option, either: (i) repair the Product(s); (ii) replace the Product(s) with a new or refurbished Product(s) (replacement Product(s) being of identical model or functional equivalent); or (iii) provide you a refund of the price you paid for the Product(s).

This Limited Warranty of KLT is solely limited to repair and/or replacement on the terms set forth above. KLT is not reliable or responsible for any subsequent events.





CMOS CAMERA MODULES



your BEST camera module partner

KLT Strength

Powerful Factory



Professional Service



Promised Delivery



www.KaiLapTech.com sales@KaiLapTech.com Tel: (852) 6908 1256 Fax: (852) 3017 6778

All rights reserved @ Kai Lap Technologies Group Ltd. Specifications subject to change without notice.